

INSTRUCTION SHEET

A

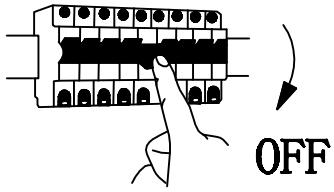

B

39127

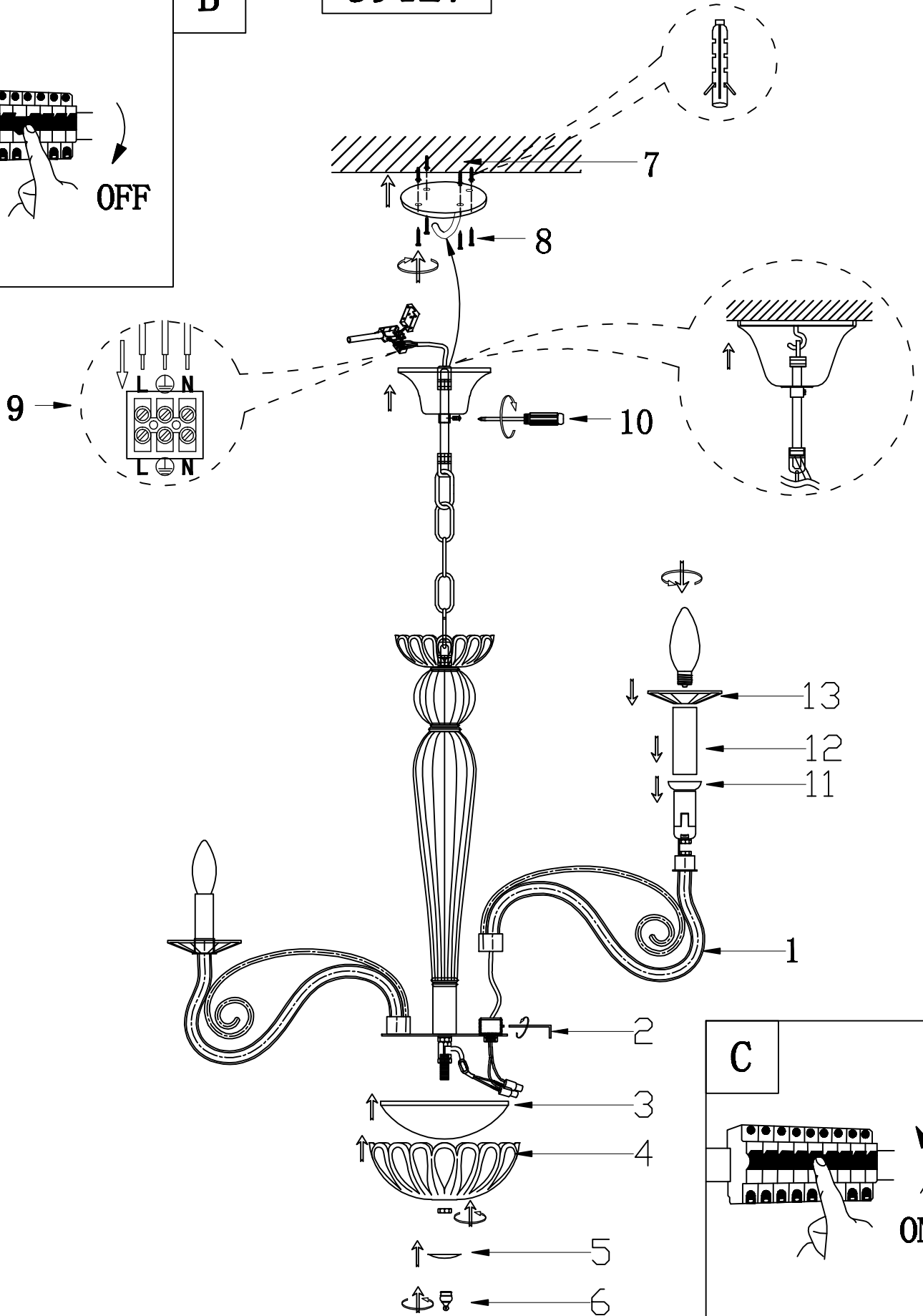

C

